



## Power Meter R&S NRP

in **R&S SMART SENSOR TECHNOLOGY**

- ◆ Innovative multipath sensor technology
- ◆ 90 dB dynamic range
- ◆ High measurement speed
- ◆ Intelligent sensors – simply plug in and measure
- ◆ Accurate measurement of average power regardless of bandwidth and modulation
- ◆ Multislot measurements for common time division systems (e.g. GSM/EDGE, DECT)
- ◆ Handling of external components through  $\Gamma$  and s-parameter correction
- ◆ Simultaneous operation of up to 4 sensors on basic unit
- ◆ Operation of sensor directly from PC via USB interface
- ◆ 2-year calibration cycle

# Ready for a wide variety of applications

The RF and microwave Power Meter R&S NRP is always the right choice: It is ideal for daily use in research and development, production or mobile service, not to mention when analyzing broadband modulation signals of third-generation mobile radio. The versatility of the novel R&S NRP power meter series is primarily due to the newly developed sensors in **R&S SMART SENSOR TECHNOLOGY**. These sensors are intelligent standalone instruments that communicate with the basic unit or a PC via a digital interface. The **R&S SMART SENSOR TECHNOLOGY**, now implemented for the first time, sets new standards in terms of universality and accuracy. The R&S NRP basic unit offers exactly what you expect for today's needs: compact size, intuitive user interface and multichannel capability.

## Designed for R&D

Top measurement accuracy plus a dynamic range of 90 dB for broadband signals of any modulation are the most requested characteristics of a modern power meter. The versatile R&S NRP sensors in **R&S SMART SENSOR TECHNOLOGY** feature exactly these characteristics and are a priceless investment if you wish to meet future requirements such as the broadband modulation types of third-generation mobile radio. In addition, they are also capable of handling the RF bandwidths beyond 100 MHz that are already under discussion for wireless LAN.

A power meter must of course be easy to operate: The numerous sensor functions can be activated via an intuitive user interface, and the high-resolution display indicates up to 4 measurement results at a time. As with other power meters from Rohde&Schwarz, all calibration data is stored in the sensor, which ensures high-precision measurements by minimizing operating errors.



Sensor connectors on front panel, channel B: option R&S NRP-B2

Built-in test generator (option R&S NRP-B1)

Display of up to 4 measurement results

Softkeys and window-oriented menu technique

Function keys for fast access to important functions

Power sensor in **R&S SMART SENSOR TECHNOLOGY** with 90 dB dynamic range

## Ideal for production

If you have ever dealt with microwave power measurements, you know that the necessary filtering of results due to the noise characteristics of the sensor as well as delays in measurement range selection and command/result processing can have negative effects on throughput in production. And this is where the R&S NRP with its innovative features offers straightforward solutions:

- ◆ Autofilter
- ◆ Parallel processing
- ◆ Speed

It goes without saying that the basic unit, which can accommodate up to 4 sensors at the same time, can be fully remote-controlled. In addition, the sensors can directly be connected to a PC. It is good to know that the sensors can perform reliable measurements for an extended period of time owing to the long calibration interval of 2 years.

## Mobile use

The handy, lightweight and sturdy instrument, which can also be powered from the optional battery for several hours, makes mobile use a pleasure. With an operating temperature range from 0°C to 50°C, the Power Meter R&S NRP can be used under almost any conditions.

**R&S SMART SENSOR TECHNOLOGY** allows every R&S NRP sensor to be operated directly from a PC, making it the smallest and most lightweight microwave measuring instrument available.

## For any type of test signal:

### **R&S SMART SENSOR TECHNOLOGY**

Microwave power meters have historically required a multitude of different sensors to cover all applications. Thermal sensors, diode sensors as well as peak power sensors were used to handle the various measurement tasks. The sensors of the R&S NRP family now make life much easier – in many cases, a single sensor can perform all necessary measurements (see table 1).

**Table 1: Sensor technologies and their applications**

Application ↓	Sensor →	Thermoelectric sensor	Diode sensor (CW)	Peak power sensor
Average power		✓✓	✓	✓
Burst power		—	—	✓✓
Time gating		—	—	✓✓
Signal with extremely high bandwidth		✓✓	✓	—
Measurement over wide dynamic range		—	✓✓	✓

✓✓ optimal      ✓ possible      — not possible

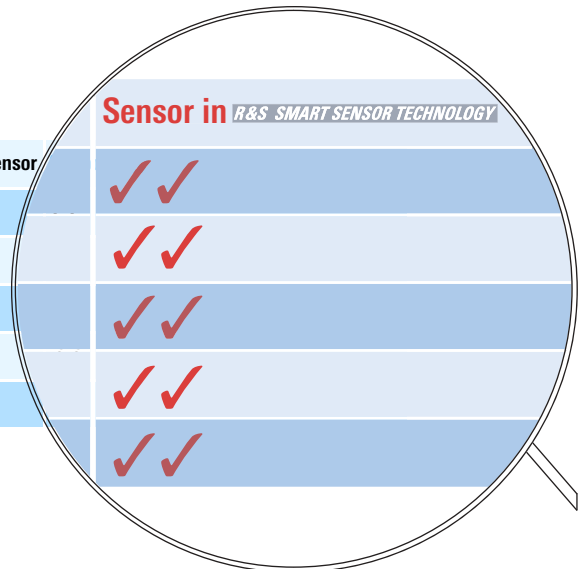

## Summary

- ◆ **One** power sensor
- ◆ 90 dB dynamic range
- ◆ CW **and** broadband-modulated signals
- ◆ Time-gating applications
- ◆ High measurement accuracy and speed

# High system accuracy through **R&S SMART SENSOR TECHNOLOGY**

## Plug in and measure

The accuracy of microwave power measurements essentially depends on the characteristics of the sensor, but it is impossible to eliminate level, temperature and frequency influences by traditional means. Rohde&Schwarz solved this problem years ago by introducing a novel approach: Measure the deviations of each manufactured sensor from the ideal characteristics and then store the values in the sensor as a data record. This means that you do not have to bother with calibration data. Instead, you simply plug in the sensor and start the measurement, which is a significant advantage in day-to-day work.

## Precise calibration

A power sensor can only be as good as the measuring instruments used to calibrate it. This is why the standards employed by Rohde&Schwarz are directly traceable to the power standards of the German Standards Laboratory (PTB).

## High measurement accuracy – even with modulated signals

Benefitting from all the factors described above, Rohde&Schwarz broadband power meters have a very low measurement uncertainty, which is still the decisive argument in their favour. In the past, however, the data sheet specifications of about 2% (0.09 dB) could seldom be achieved in practice. This was due to error sources associated with the test signal or external circuitry: harmonics and nonharmonics, modulation, mismatch of the source, and the influence of attenuators and directional couplers connected ahead of the sensor for level matching.

The R&S NRP sensors represent a big step forward in solving these problems. The concept of **R&S SMART SENSOR TECHNOLOGY** (see page 5) comprises an entire series of measures intended to make the sensors similar to thermal sensors in behaviour. This includes very accurate measurement of average power, regardless of modulation (FIG 1), as well as high immunity to incorrect weighting of harmonics, spurious and other interference signals. The maximum speed of 1500 measurements per second (in buffered mode, measurement interval  $2 \times 100 \mu\text{s}$ ) nevertheless equals that of diode sensors.

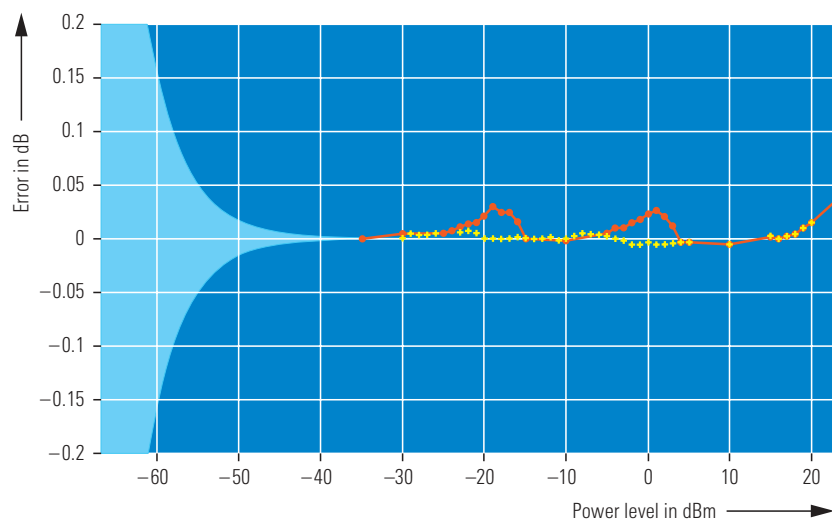

**FIG 1: Modulation-related errors of an R&S NRP-Z11 or R&S NRP-Z21 power sensor for a 3GPP test signal (test model 1-64) compared to a CW signal of the same magnitude.**

**Red: default setting; yellow: transition area between measurement paths shifted by -6 dB; light blue: uncertainty caused by noise (modulation effect below -30 dBm negligible).**

# R&S SMART SENSOR TECHNOLOGY

The Power Sensors R&S NRP-Z11 and R&S NRP-Z21 fuse multiple-path architecture, multiple-diode technology and a simultaneously scanning multichannel measurement system into a unique high-performance concept.

Multiple-path architecture is the combination of two or three diode detectors to obtain a large dynamic range for modulated signals. This is achieved by operating each detector exclusively in the square-law region and by using only the optimally driven detectors for the measurement.

Multiple diodes comprise several zero-bias Schottky diodes connected in series and integrated on one chip. When used in an RF detector, they expand its square-law region, because the measurement voltage is split among several diodes – so that each one is driven less – while at the same time the detected voltages of the individual diodes are added together.

Rohde&Schwarz's multiple-path architecture (patent pending) is characterized by the following features (FIG 2):

- ◆ 3 signal paths, each fitted with triple diodes
- ◆ 6 dB wide overlap ranges, smooth transitions
- ◆ Simultaneous scanning and analysis
- ◆ Chopper stabilization of signal paths for recurring signals

The advantages over conventional technology are obvious: high signal/noise ratio throughout, low modulation effect, negligible delays and discontinuities when switching signal paths, as well as the ability to perform a time-domain analysis of the test signal within the available video bandwidth.

As a consequence, these sensors not only compete with peak power meters – they are indeed superior in two respects:

- ◆ No restrictions on the RF bandwidth of the test signal
- ◆ Wider dynamic range

As a result, it is already possible today to analyze extremely broadband signals, such as are planned for wireless LAN or will be created by combining several carriers in accordance with 3GPP.

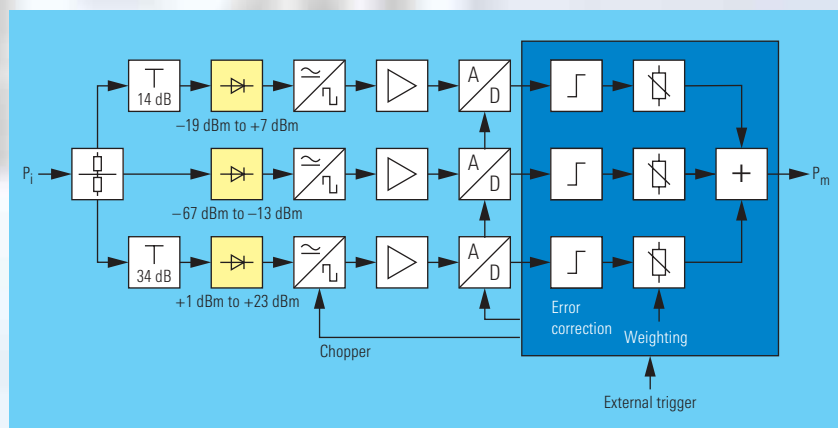

FIG 2: Sensor architecture in R&S NRP-Z11 and R&S NRP-Z21.

# Power measurement without external influences

## $\Gamma$ correction – accounting for the source mismatch

The most important source of error in power measurements on RF and microwave signals is the mismatch of source and sensor. Due to reflections that cannot be eliminated, it is not the nominal power  $P_{GZ0}$  of the source that is transmitted to the power sensor, but the power  $P_i$  (FIG 3) that deviates to a certain extent from the nominal value. To minimize the influence of mismatched sources, the standing wave ratio (SWR) at the sensor end was reduced to the extent technically feasible (1.11). However, a signal source with an SWR of 2, for example, still leads to an additional uncertainty of the measurement result of  $\pm 3.5\%$  (0.15 dB). Although this error normally is decisive for total measurement uncertainty, it was frequently not taken into account because it could not be specified for the sensor alone.

Here the R&S NRP sensors boast another innovation: To reduce the mismatch, the complex reflection coefficient of the source is transmitted to the sensor via the USB data interface, and the sensor corrects the matching error by means of  $\Gamma$  correction, taking into consideration its own low impedance mismatch. This approach yields a measurement result of significantly higher precision.

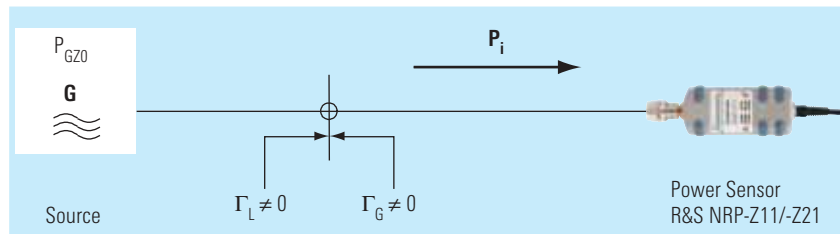

**FIG 3:**  $\Gamma$  correction function: By taking into account the complex reflection coefficient  $\Gamma_G$  of the source, the measurement result ( $P_i$ ) is corrected in such a way that the nominal power of the source  $P_{GZ0}$  is displayed.

## S-parameter correction – accounting for additional components

A similar mismatch problem is encountered in test setups where the sensor cannot be connected directly to the source to be measured. Especially in production facilities, it is often necessary to connect a cable or an attenuator for level matching. In this case, the interactions between three components must be taken into account – a non-trivial bit of mathematics involving complex numbers.

Here, too, the R&S NRP offers a straightforward, standardized solution to the user. With the help of a small software tool that runs on any PC, the complete s-parameter data set of the twoport connected ahead can be loaded into the sensor's memory via the USB data interface.

The data format required (s2p/Touchstone) is provided by any vector network analyzer.

After the source's complex reflection coefficient has been transmitted (optionally), a perfectly corrected reading is obtained; the sensor practically behaves as if it were connected directly to the source (FIG 4).

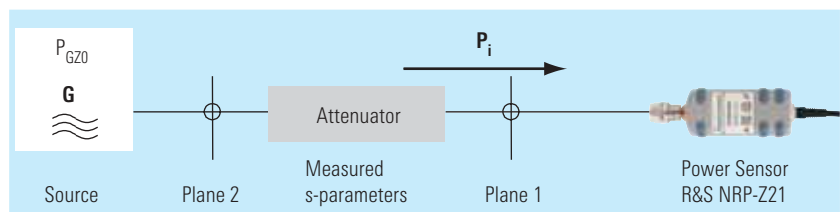

**FIG 4:** Shifting the measurement plane from 1 to 2 by means of s-parameter correction. The influence of the additional component is compensated for, so that the nominal power  $P_{GZ0}$  of the source is measured.

# Throughput is essential in production

## New autofilter function – averaging made simple

The setting of the display filter is essential for the measurement speed that can be attained. As a rule, noise is superimposed on the signal to be measured. The relative noise content increases as power decreases. To obtain a noise-reduced display, an averaging factor has to be selected for low signal levels, but such a factor increases the measurement time. Therefore a compromise must be made between sufficient signal/noise ratio and acceptable measurement time. The following rule of thumb applies: Reducing the noise by a factor of 10 increases the measurement time by a factor of 100. With the classic autofilter function, the averaging factor is, therefore, only increased gradually, which keeps the measurement time acceptable but does not make it possible to maintain a specific noise level.

The enhanced autofilter function, now implemented in a power meter for the first time, mitigates this problem. In addition to the classic autofilter function, a Fixed Noise mode is available. Using this mode, the sensor will maintain the user-defined S/N ratio as long as the maximum measurement time (to be defined by the user) is not exceeded. Consequently, the instrument provides stable measurement results exactly matched to the user's needs.

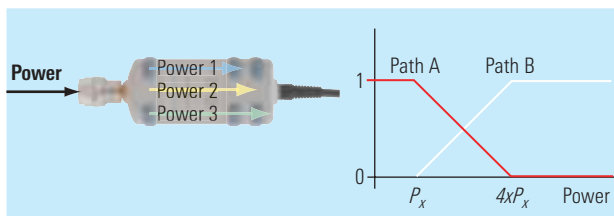

**FIG 6: Parallel signal processing and soft transitions between measurement paths owing to R&S SMART SENSOR TECHNOLOGY.**

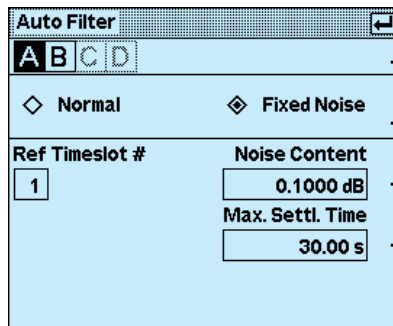

**FIG 5: Autofilter menu of the R&S NRP.**

## Measurement range selection without delay

Multipath concepts for diode sensors often have the disadvantage of hard switching from path A to path B in the case of level changes, which interrupts measurement data acquisition and introduces large differential linearity errors. This disadvantage has been eliminated in the R&S NRP diode sensors in

**R&S SMART SENSOR TECHNOLOGY** owing to parallel signal processing in the three paths and soft transitions from one path to the other.

## User-definable measurement window

Measurements on very low-frequency-modulated signals are typically performed using large averaging factors to keep the display stable. This, however, extends the measurement time. The R&S NRP uses a different approach: The measurement time interval is adapted to the signal period by means of windowing. The use of an integer multiple of the period yields a perfectly stabilized measurement result.

## High measurement speed

All these requirements, i.e. optimum filtering and fast range selection, must be met before a power meter can make full use of its measurement speed under any conditions. If filtering is not necessary and the size of the measurement window is not critical, the R&S NRP excels with its 1500 measurements per second (in buffered mode, measurement interval  $2 \times 100 \mu\text{s}$ ).

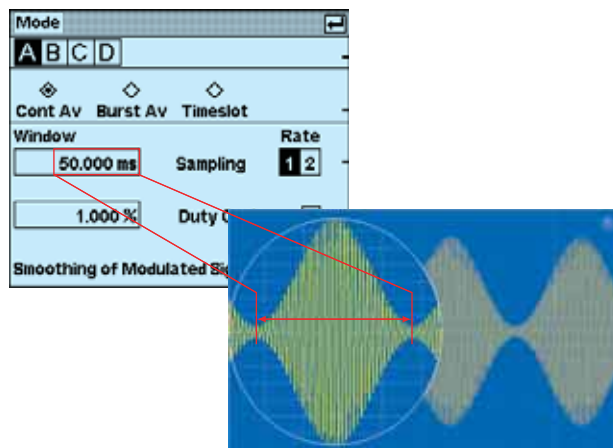

**FIG 7: Windowing technique used on a low-frequency-modulated signal.**

# Signal-synchronized measurements

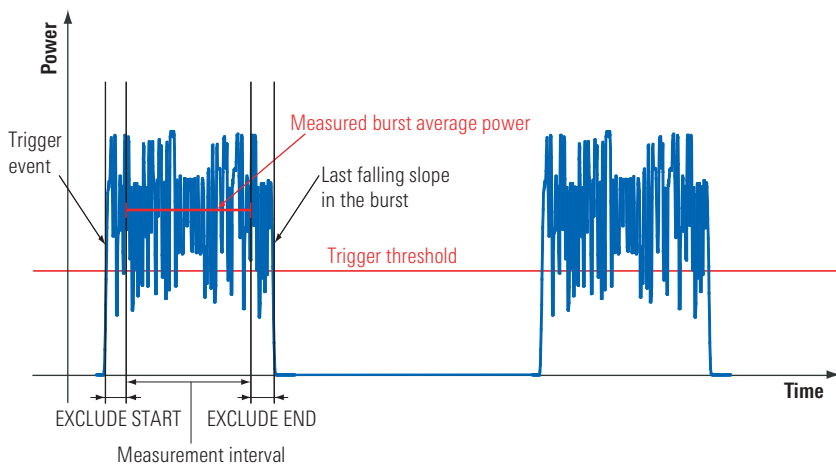

**FIG 8: Modulated burst of an EDGE signal and relevant parameters for measuring burst average power.**

## Just in time

The R&S NRP-Z11 and R&S NRP-Z21 sensors can measure the average power not only in the classic manner, i.e. continuously without temporal reference to the signal content, but also synchronized with the signal over definable periods of time. Power measurements on signal bursts and within individual timeslots of time division systems are important applications. A fundamental prerequisite for signal-synchronized measurements is the availability of extensive trigger capabilities. The Power Meter R&S NRP can derive the trigger time from the test signal (internal triggering) or from an external trigger signal.

## Automatic burst acquisition and measurement

The internal trigger capabilities of the Power Meter R&S NRP are particularly useful for burst measurements. Depending on the trigger level previously defined, the sensor automatically determines the beginning and the end of the burst. This is even accomplished for modulated bursts by defining of a dropout parameter, i.e. a minimum signal-off period that must be detected by the sensor to reliably determine the end of the burst.

In addition, unwanted power components at the beginning or end of the burst can be excluded from the displayed result by using the commands EXCLUDE START and EXCLUDE END (FIG 8).

## Multislot measurements

This function enables the R&S NRP to carry out measurements on signals with complex timeslot structure. Up to 128 intervals (26 when controlled by the basic unit) can be acquired and measured at the same time (FIG 9). This allows entire frames of GSM/EDGE signals to be analyzed. The user can select the number and the timing of the timeslots relative to the trigger event; up to 4 results can simultaneously be displayed on the basic unit. The unwanted portions in the transition from one timeslot to the next can be blanked by user-definable exclusion periods.

The internal trigger capabilities of the R&S NRP can also be used in this context. In the case of TDMA signals, using an external frame trigger is often beneficial to generate the temporal relation to timeslot 1. The basic unit is fitted with the appropriate connector on the rear panel; if the sensor is operated from a PC, triggering via the Adapter R&S NRP-Z3 is possible.

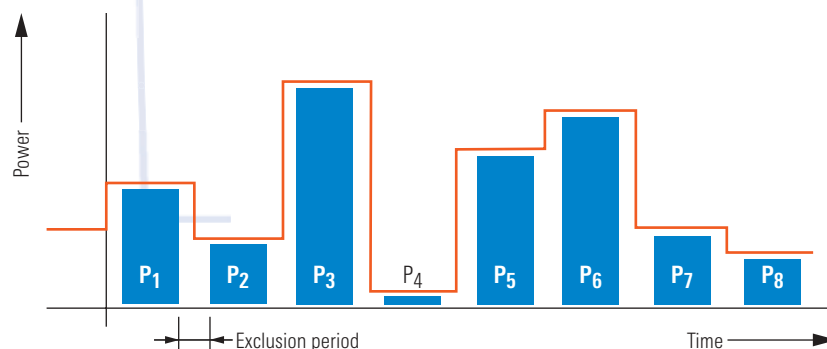
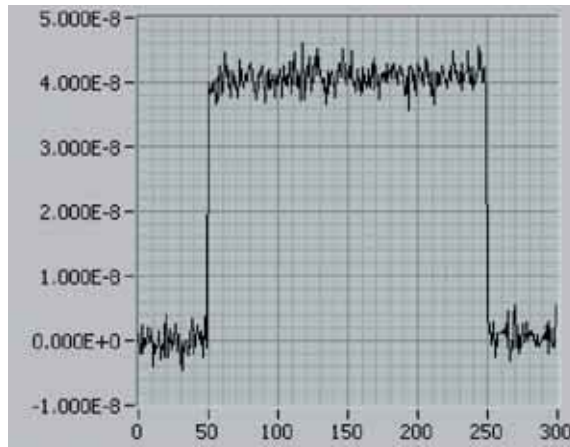

**FIG 9: Multislot measurement: for the most common time division methods (e.g. GSM/EDGE, DECT), average power can be measured in all timeslots at the same time.**



## Power/time template

If the R&S NRP-Z sensors are operated from a PC (see page 10), more in-depth analysis functions are available. Recurring or non-recurring waveforms can be displayed as power/time templates (FIG 10). The number of test intervals (points) can be increased to 1024; signal details down to a duration of about 10  $\mu$ s can thus be resolved. Extensive trigger functions, derived from an external source or the test signal, again ensure stable conditions.



**FIG 10: Power/time template of a nonrecurring RF burst for an application in medical electronics, measured with the R&S NRP-Z11 (LabView application without basic unit; readings in W and ms, no averaging).**

## Outstanding dynamic range

In the past, the limited dynamic range of standard sensor technologies forced many users to employ sensors of different sensitivity (nominal power) to handle the power range of the test items. This was especially true if average power of modulated signals had to be measured. Although conventional multipath sensors were able to attain respectable values, their dynamic range was limited to 80 dB, not to mention the slow response times and the significant measurement errors in the transition regions of the individual paths. The R&S NRP-Z11 and R&S NRP-Z21 are the first sensors with outstanding values: For the first time, a dynamic range of 90 dB for broadband signals of any modulation has been

achieved, while the lower measurement limit (defined by noise and zero offset) remains a very respectable  $-67$  dBm. With signal-synchronized measurements, the difference between the new sensors and previous power sensors is most evident.

For signal-triggered measurements of the average power of single bursts or the generation of a power/time template, a wider dynamic range is available than with all existing conventional designs.

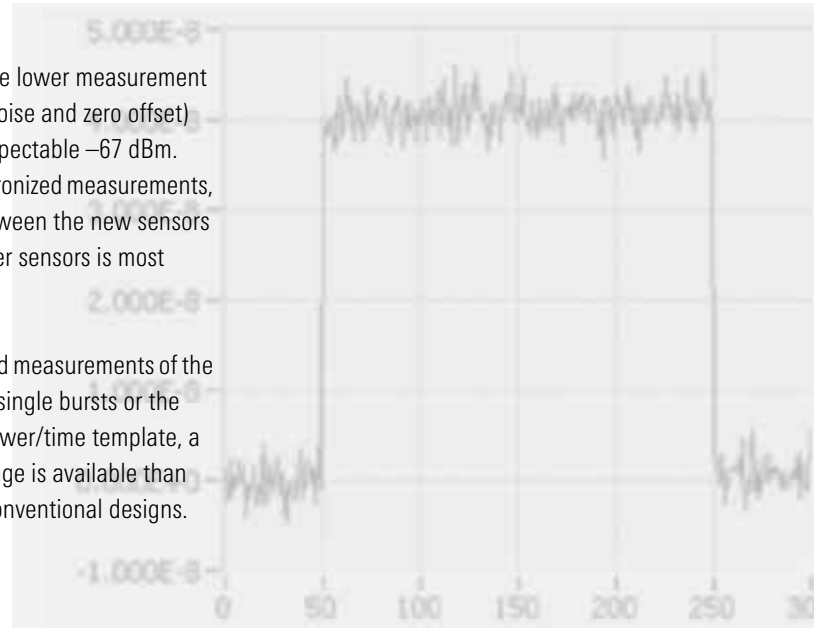

**Table 2: Dynamic range for measuring average power (bandwidth of test signal 100 MHz/5 MHz/0 (CW))**

Technology ↓	Mode ↓			
	Continuous	Timeslot 1 out of 8 (external trigger)	Burst duty cycle 1:8 (internal trigger)	Power versus time 256 points (external trigger)
Thermoelectric sensor	50/50/50 dB	–	–	–
Diode: Sensor in square-law region	43/43/50 dB	–	–	–
Diode: CW sensor	43/43/90 dB	–	–	–
Diode: Peak sensor	33/50/80 dB	–/50/57 dB	–/33/37 dB	–/50/57 dB
Diode: Multiple-path sensor	80/80/80 dB	–	–	–
<b>Diode:</b> <i>R&amp;S SMART SENSOR TECHNOLOGY</i>	<b>90/90/90 dB</b>	<b>85/85/85 dB</b>	<b>60/60/60 dB</b>	<b>70/70/70 dB</b>

# Sensor with PC interface

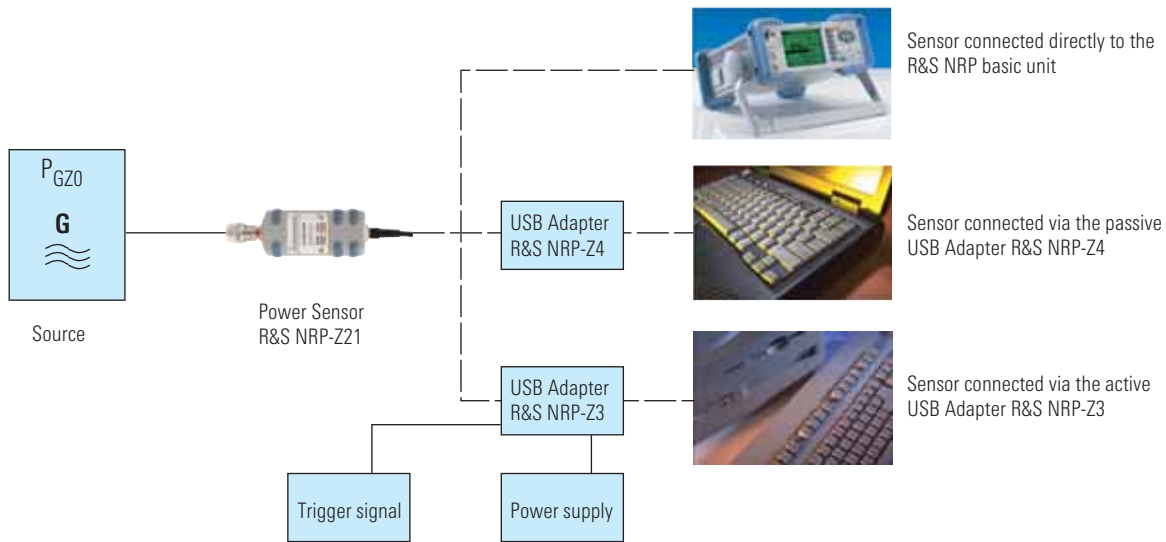

FIG 11: Three ways of displaying results with an R&S NRP sensor.

## Miniature power meter

The sensors of the R&S NRP-Z series can be used as standalone measuring instruments without the basic unit. In addition to the power sensor itself, they include a CPU that controls the sensor, processes the measurement results and operates the interface: a complete miniature power meter. All measurement data and settings are transmitted via a digital USB interface. This concept, with which Rohde&Schwarz already set the pace in the field of directional power meters, is now being used for the first time in classic microwave power measurements.

## Use on a PC

The most cost-effective method for high-precision power measurements is to connect the sensors directly to a PC, especially if data acquisition and evaluation take place via a PC. The main area of application is production, since production environments usually include a process controller. The fact that the basic unit can be omitted saves space in the rack and reduces costs.

Service technicians will also appreciate this option since the power meter fits into a trouser pocket and can easily be operated from a laptop.

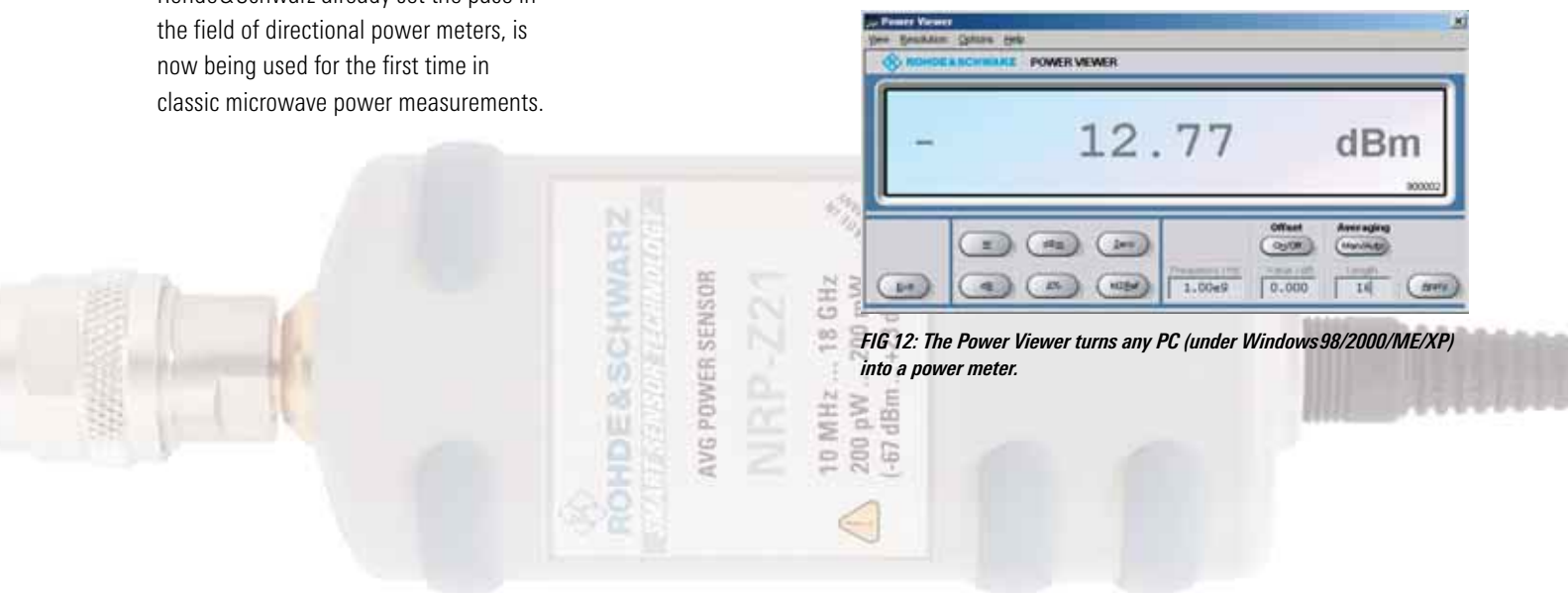

FIG 12: The Power Viewer turns any PC (under Windows98/2000/ME/XP) into a power meter.

The software toolkit supplied as standard with every R&S NRP sensor is required in order to control the R&S NRP power sensors via a PC. The software toolkit comes with both a DLL (dynamic link library), for individualized use of the entire sensor functionality under Windows, and the Power Viewer, a virtual power meter with basic measurement functions (subset of the R&S NRP functionality) for the PC workstation (FIG 12).

Two adapters are available for connection to the hardware:

- ◆ The passive USB Adapter R&S NRP-Z4 provides all basic functions, as it handles the transmission of settings and measurement data as well as the power supply of the sensor.
- ◆ The active USB Adapter R&S NRP-Z3 has been developed for applications requiring external triggering of the power sensor. It also offers a separate power supply.

## Universal basic unit

For applications requiring a basic unit, the R&S NRP offers everything that is expected from a modern power meter – and much more. It is small, lightweight and rugged, and the optional battery pack ensures several hours of operation without line power. Depending on requirements, it can be fitted with one, two or four measurement inputs (options R&S NRP-B2 and R&S NRP-B5).

The IEC/IEEE bus connector is a standard feature as are the trigger input and the analog measurement output.

The user interface of the power meter takes its cue from the PC world: The basic unit is controlled via menu bars, menus and dialog boxes, and uses only three menu levels despite the large number of functions. The self-explanatory operating concept makes the R&S NRP a pleasure to use.

The high-resolution graphical display can show as many as four measurement results at the same time. The user can choose which results to display – either the data from different sensors (with a maximum of four connected simultaneously) or from different timeslots of a TDMA signal measured by means of one sensor. Even values obtained by calculation, such as SWR or return loss, can be displayed. For immediate clarity, each data window can be assigned a specific name.



FIG 13: The Power Meter R&S NRP can be equipped with one, two or four measurement inputs (two on rear panel, see red frame).

## Specifications

### Power Sensors R&S NRP-Z11/-Z21 (specifications from 8 GHz to 18 GHz apply only to R&S NRP-Z21)

**Bold:** Parameter 100% tested.

*Italics:* Uncertainties calculated from the test assembly specifications and the modelled behaviour of the sensor.

Normal: Compliance with specifications is ensured by the design or derived from the measurement of related parameters.

<b>Sensor type</b>	3-path diode sensor
<b>Measurand</b>	average power of incident wave or average power of source into $50 \Omega^{11}$
<b>Frequency range</b>	10 MHz to 8 GHz (R&S NRP-Z11) 10 MHz to 18 GHz (R&S NRP-Z21)
<b>Matching (SWR)</b>	values in ( ) for temperature range 15 °C to 35 °C
10 MHz to <30 MHz	<1.15 ( <b>1.13</b> )
30 MHz to 2.4 GHz	<1.13 ( <b>1.11</b> )
>2.4 GHz to 8.0 GHz	<1.20 ( <b>1.18</b> )
>8.0 GHz to 18.0 GHz	<1.25 ( <b>1.23</b> )
Level-dependent matching change <sup>2)</sup>	
10 MHz to 2.4 GHz	<0.05 (0.02)
>2.4 GHz to 18.0 GHz	<0.10 (0.07)
<b>RF connector</b>	N (male)
<b>Power measurement range</b>	
Continuous Average	200 pW to 200 mW (-67 dBm to +23 dBm)
Burst Average	200 nW to 200 mW (-37 dBm to +23 dBm)
Timeslot	650 pW to 200 mW (-62 dBm to +23 dBm) <sup>3)</sup>
Scope	10 nW to 200 mW (-50 dBm to +23 dBm) <sup>4)</sup>
<b>Max. power</b>	
Average	0.4 W (+26 dBm) continuous
Peak envelope power	1.0 W (+30 dBm) for max. 10 $\mu$ s
<b>Measurement subranges</b>	
Path 1	-67 dBm to -14 dBm
Path 2	-47 dBm to + 6 dBm
Path 3	-27 dBm to +23 dBm
<b>Transition ranges</b>	
With automatic path selection, user def'd crossover <sup>5)</sup> set to 0 dB	(-19 $\pm$ 1) dBm to (-13 $\pm$ 1) dBm (+1 $\pm$ 1) dBm to (+7 $\pm$ 1) dBm
<b>Measurement functions</b>	
Stationary and periodically modulated signals	Continuous Average Burst Average Timeslot Scope <sup>6)</sup> Scope <sup>6)</sup>
Non-recurring waveforms	Scope <sup>6)</sup>
<b>Continuous Average function</b>	
Continuous measurement of average power	
Measurement window <sup>7)</sup>	2 x (10 $\mu$ s to 300 ms)
Duty cycle correction <sup>8)</sup>	0.001 % to 100.00%
Smoothing	see under Measurement window (page 13)
Capacity of measurement buffer <sup>9)</sup>	1 to 1024 results

<b>Burst Average function</b>	
Measurement of average burst power with automatic detection of burst (trigger settings required)	
Detectable burst width	20 $\mu$ s to 100 ms
Minimum gap between bursts	10 $\mu$ s
Dropout tolerance <sup>10)</sup>	0 ms to 3 ms
Exclusion periods <sup>11)</sup>	
Excluded from Start	0 ms to 100 ms
Excluded from End	0 ms to 3 ms
Measurement window <sup>7)</sup>	2 x (burst width – Excl. from Start – Excl. from End)
<b>Timeslot function</b>	
Measurement of average power in one or more equidistant, successive timeslots	
Duration (nominal width)	10 $\mu$ s to 100 ms
Number of timeslots	1 to 128 (26 in case of operation from R&S NRP basic unit)
Exclusion periods <sup>11)</sup>	
Excluded from Start	0 ms to 100 ms
Excluded from End	0 ms to 3 ms
Measurement window (per timeslot) <sup>7)</sup>	2 x (nom. width – Excl. from Start – Excl. from End)
<b>Scope function</b>	
Measurement of power versus time	
Modes	for recurring and non-recurring waveforms (single)
Measurement window $\Delta^{12)}$	
Recurring	2 x (100 $\mu$ s to 300 ms)
Non-recurring	100 $\mu$ s to 300 ms
Number of measurement points M	1 to 1024
Resolution $\Delta/M$	$\geq 10 \mu$ s
Beginning of measurement window (referenced to trigger)	-5 ms to 100 s
<b>Dynamic behaviour of video path</b>	values in ( ) for temperature range 15 °C to 35 °C
Bandwidth	>50 kHz (100 kHz)
Rise time 10%/90%	<8 $\mu$ s (4 $\mu$ s)
<b>Sampling frequencies</b>	
Frequency 1 (default)	133.358 kHz
Frequency 2 <sup>13)</sup>	119.467 kHz
<b>Display noise<sup>14)</sup></b>	values in [ ]: 8 GHz to 18 GHz
15 °C to 35 °C	Path 1 <60 pW [64 pW] (40 pW typ.) Path 2 <5.6 nW [6.0 nW] (3.6 nW typ.) Path 3 <0.56 $\mu$ W [0.60 $\mu$ W] (0.36 $\mu$ W typ.)
0 °C to 50 °C	Path 1 <65 pW [69 pW] Path 2 <6.3 nW [6.6 nW] Path 3 <0.63 $\mu$ W [0.66 $\mu$ W]
<b>Display noise, relative<sup>15)</sup></b>	
Measurement window 2 x 100 $\mu$ s, without averaging	<0.160 dB (0.1 dB typ.)
Measurement window 2 x 20 ms, averaging factor 32 (measurement time approx. 1 s)	<0.002 dB (0.001 dB typ.)
<b>Zeroing (duration)</b>	
Depends on setting of averaging filter	
AUTO ON	4 s
AUTO OFF	
Integration time <sup>16)</sup>	<4 s 4 s 4 s to 16 s integration time <sup>16)</sup> >16 s 16 s

<b>Zero offset<sup>17)</sup></b>	values in []: 8 GHz to 18 GHz	
15°C to 35°C	Path 1	<96 pW [102 pW] (64 pW typ.)
	Path 2	<9.0 nW [9.6 nW] (5.8 nW typ.)
	Path 3	<0.90 μW [0.96 μW] (0.58 μW typ.)
0°C to 50°C	Path 1	<104 pW [110 pW]
	Path 2	<10.0 nW [10.6 nW]
	Path 3	<1.00 μW [1.06 μW]
<b>Zero drift<sup>18)</sup></b>	values in []: 8 GHz to 18 GHz	
Path 1		<35 pW [37 pW]
Path 2		<3.0 nW [3.2 nW]
Path 3		<0.30 μW [0.32 μW]
<b>Measurement error due to harmonics <math>n \times f_0</math> of carrier frequency<sup>19)</sup></b>		
Values in []: typ. standard uncertainty		
$n = 3, 5, 7, \dots$ <sup>20)</sup>	-30 dBc	<0.003 dB [0.0015 dB]
	-20 dBc	<0.010 dB [0.005 dB]
	-10 dBc	<0.040 dB [0.015 dB]
$n = 2, 4, 6, \dots$ <sup>20)</sup>	-30 dBc	<0.001 dB [0.0003 dB]
	-20 dBc	<0.002 dB [0.001 dB]
	-10 dBc	<0.010 dB [0.003 dB]
<b>Modulation influence<sup>21)</sup></b>	values in []: User def'd crossover $\leq -6$ dB	
General	measurement errors in subranges are proportional to power and depend on CCDF and modulation bandwidth of test signal	
WCDMA (3-GPP Test Model 1-64) Worst case	-0.02 dB to +0.07 dB [-0.02 dB to +0.02 dB]	
Typical	-0.01 dB to +0.03 dB [-0.01 dB to +0.01 dB]	
<b>Averaging filter</b>		
Modes	AUTO OFF (fixed averaging factor) AUTO ON (continuously auto-adapted) AUTO ONCE (automatically fixed once)	
AUTO mode		
Reference power		
Continuous Average	non-averaged result in measurement window	
Burst Average	non-averaged result in measurement window	
Timeslot	non-averaged result in reference timeslot <sup>25)</sup>	
Scope <sup>22)</sup>	non-averaged result at reference point <sup>25)</sup>	
Normal operating mode <sup>23)</sup>	setting of filter depends on power to be measured and resolution	
Resolution	1 (1 dB), 2 (0.1 dB), 3 (0.01 dB), 4 (0.001 dB)	
Fixed Noise operating mode	filter set to specified noise content	
Noise content	0.0001 dB to 1 dB	
Max. measurement time <sup>24)</sup>	0.01 s to 999 s	
Averaging factor N	1 to 2 <sup>16)</sup> (number of averaged measurement windows)	
Result output		
Moving Average	continuous with every newly evaluated measurement window (e.g. in case of manual operation via R&S NRP)	
Repeat	only final result (e.g. in case of remote control of R&S NRP)	

<b>Measurement window</b>	
Duration	as specified for the individual measurement functions
Shape	rectangular (integrating behaviour; available for all measurement functions) Von Hann (smoothing filter, for efficient suppression of result variations due to modulation <sup>26)</sup> ; only for Continuous Average function)
<b>Measurement times<sup>27)</sup></b>	
Continuous Average	$N \times (\text{duration of measurement window}^{27)} + 0.2 \text{ ms}) + t_z$
Buffered, without averaging	buffer size $\times$ (duration of measurement window <sup>27)</sup> + 0.5 ms) + $t_z$
Burst Average	$(2 \text{ to } 4) \times N \times \text{burst period} + t_z$
Timeslot, Scope	$(2 \text{ to } 4) \times N \times \text{trigger period} + t_z$ <sup>28)</sup> $t_z < 1.6 \text{ ms}$ (0.9 ms on average)
<b>Triggering</b>	
Source	Bus, External, Hold, Immediate, Internal
Slope (external, internal)	pos./neg.
Level	
Internal	-40 dBm to +23 dBm
External	see specs of R&S NRP and USB Adapter R&S NRP-Z3
Delay	-5 ms to +100 s
Holdoff	0 s to 10 s
Hysteresis	0 dB to 10 dB
<b>Attenuation correction</b>	
Function	correcting the measurement result by means of a fixed factor (dB offset)
Range	-100.000 dB to +100.000 dB
<b>S-parameter correction</b>	
Function	taking into account a component connected ahead of the sensor by loading its s-parameter data set into the sensor 1 to 1000
Number of frequencies	
Parameters	$S_{11}$ , $S_{21}$ , $S_{12}$ and $S_{22}$ (in s2p format)
Download	with R&S NRP toolkit (supplied with sensor) via USB Adapter R&S NRP-Z3 or R&S NRP-Z4
<b><math>\Gamma</math> correction</b>	
Function	reducing the influence of mismatched sources <sup>29)</sup>
Parameters	magnitude and phase of reflection coefficient of source
Download	see under S-parameter correction
<b>Frequency response correction</b>	
Function	taking into account the calibration factors relevant for the test frequency
Parameter	carrier frequency (center frequency)
Permissible deviation from actual value	50 MHz (0.05 $\times$ f below 1 GHz) for specified measurement uncertainty

<b>Interface to host</b>	
Power supply	+5 V/200 mA typ. (USB high-power device)
Remote control	as a USB device (function) in full-speed mode, compatible with USB 1.0/1.1/2.0 specifications
Trigger input	differential (0/+3.3 V)
<b>Dimensions</b> (W x H x L)	48 mm x 31 mm x 170 mm length incl. connecting cable: approx. 1.6 m
<b>Weight</b>	<0.3 kg

### Calibration uncertainty<sup>30)</sup> in dB

10 MHz to <20 MHz			20 MHz to <100 MHz			20°C to 25°C
Path 1	Path 2	Path 3	Path 1	Path 2	Path 3	
0.056	0.047	0.048	0.056	0.047	0.047	
100 MHz to 4 GHz			>4 GHz to 8 GHz			20°C to 25°C
Path 1	Path 2	Path 3	Path 1	Path 2	Path 3	
0.066	0.057	0.057	0.083	0.071	0.072	
>8 GHz to 12.4 GHz			>12.4 GHz to 18 GHz			20°C to 25°C
Path 1	Path 2	Path 3	Path 1	Path 2	Path 3	
0.094	0.076	0.076	0.123	0.099	0.099	

### Uncertainty for absolute power measurements<sup>31)</sup> in dB

10 MHz to <20 MHz				20 MHz to <100 MHz				0°C to 50°C 15°C to 35°C 20°C to 25°C
-40 to (-67)	-19	+1	+23	-40 to (-67)	-19	+1	+23	
0.174	0.175	0.175		0.147	0.159	0.159		
0.075	0.070	0.071		0.072	0.069	0.069		
0.056	0.047	0.048		0.056	0.047	0.048		
100 MHz to 4 GHz				>4 GHz to 8 GHz				0°C to 50°C 15°C to 35°C 20°C to 25°C
-40 to (-67)	-19	+1	+23	-40 to (-67)	-19	+1	+23	
0.150	0.162	0.164		0.160	0.170	0.174		
0.081	0.077	0.081		0.096	0.089	0.097		
0.066	0.058	0.063		0.083	0.072	0.082		
>8 GHz to 12.4 GHz				>12.4 GHz to 18 GHz				0°C to 50°C 15°C to 35°C 20°C to 25°C
-40 to (-67)	-19	+1	+23	-40 to (-67)	-19	+1	+23	
0.168	0.176	0.184		0.188	0.196	0.210		
0.106	0.096	0.110		0.133	0.120	0.142		
0.094	0.079	0.096		0.123	0.103	0.128		

### Uncertainty for relative power measurements<sup>32/33)</sup> in dB

	10 MHz to <20 MHz			20 MHz to <100 MHz			0°C to 50°C 15°C to 35°C 20°C to 25°C
	-40	-19/-13	±0/+8	-40	-19/-13	+1/+7	
+23	0.226	0.229	0.027	0.206	0.215	0.027	
+8	0.084	0.080	0.022	0.082	0.078	0.022	
±0	0.046	0.044	0.022	0.046	<b>0.044</b>	0.022	
-13	0.226	0.027	0.229	0.205	0.027	0.215	
-19	0.083	0.022	0.080	0.081	0.022	0.078	
-40	0.045	0.022	0.044	<b>0.044</b>	<b>0.022</b>	<b>0.044</b>	
	0.023	0.226	0.226	0.023	0.205	0.206	
	0.022	0.083	0.084	0.022	0.081	0.082	
	0.022	0.045	0.046	0.022	<b>0.044</b>	0.046	
	-40	-19/-13	±0/+8	+23	-40	-19/-13	+1/+7
	Power level in dBm			Power level in dBm			
	100 MHz to 4 GHz			>4 GHz to 8 GHz			0°C to 50°C 15°C to 35°C 20°C to 25°C
	-40	-19/-13	+1/+7	-40	-19/-13	+1/+7	
+23	0.209	0.218	0.031	0.215	0.233	0.049	
+7	0.088	0.085	0.032	0.097	0.093	0.044	
+1	0.055	0.047	0.038	0.066	0.059	0.043	
-13	0.206	0.028	0.218	0.210	0.030	0.218	
-19	0.083	0.022	0.085	0.088	0.022	0.085	
-40	0.048	0.022	0.047	0.054	0.022	0.047	
	0.023	0.206	0.209	0.024	0.210	0.215	
	0.022	0.083	0.088	0.022	0.088	0.097	
	0.022	0.048	0.055	0.022	0.054	0.066	
	-40	-19/-13	+1/+7	+23	-40	-19/-13	+1/+7
	Power level in dBm			Power level in dBm			
	>8 GHz to 12.4 GHz			>12.4 GHz to 18 GHz			0°C to 50°C 15°C to 35°C 20°C to 25°C
	-40	-19/-13	+1/+7	-40	-19/-13	+1/+7	
+23	0.224	0.231	0.064	0.244	0.245	0.086	
+7	0.111	0.106	0.061	0.135	0.128	0.084	
+1	0.084	0.077	0.060	0.110	0.102	0.083	
-13	0.216	0.034	0.231	0.230	0.040	0.245	
-19	0.096	0.027	0.106	0.112	0.034	0.128	
-40	0.063	0.025	0.077	0.079	0.033	0.102	
	0.024	0.216	0.224	0.024	0.230	0.244	
	0.022	0.096	0.111	0.022	0.112	0.135	
	0.022	0.063	0.084	0.022	0.079	0.110	
	-40	-19/-13	+1/+7	+23	-40	-19/-13	+1/+7
	Power level in dBm			Power level in dBm			

## Accessories for sensors

### R&S NRP-Z2

<b>Extension cable</b>	for connecting the sensor to the basic unit or a USB adapter
Length Model .05 Model .10	3.5 m 8.5 m (not in conjunction with R&S NRP-Z4)
Total length incl. sensor cable	5 m (model .05) or 10 m (model .10)

### R&S NRP-Z3

<b>Active USB adapter with trigger input and plug-in power supply</b>	for connecting a sensor to the USB interface of a PC
Trigger input Maximum voltage Logic level Low High Input impedance	±15 V <0.8 V >2.0 V approx. 5 kΩ
Plug-in power supply Voltage/frequency Tolerance Current consumption Connection	100 V to 240 V, 50 Hz to 60 Hz ±10% for voltage, ±3 Hz for frequency 25 mA typ. with sensor connected via adapter to all common AC supplies (Europe, UK, USA, Australia)
Connecting cable to PC USB interface Length	type A approx. 2 m
Dimensions (W x H x L) USB adapter Plug-in power supply	48 mm x 45 mm x 140 mm 52 mm x 73 mm x 110 mm length of line to adapter: 2 m
Weight USB adapter Plug-in power supply	<0.2 kg <0.3 kg

### R&S NRP-Z4

<b>Passive USB adapter (cable)</b>	for connecting a sensor to the USB interface of a PC
USB interface Length	type A approx. 2 m

## R&S NRP basic unit

<b>Application</b>	multichannel power meter
<b>Sensors</b>	R&S NRP-Z series
<b>Measurement channels</b>	
Basic version	1
Basic version + R&S NRP-B2	2
Basic version + R&S NRP-B2 + R&S NRP-B5	4

<b>Measurement functionality</b>	
Single-channel	see sensor specifications <sup>6)</sup> , plus: relative measurement referenced to result or user-selectable reference value, storage of minima and maxima (Max, Min, Max-Min), limit monitoring
Display Absolute Relative	in W, dBm and dBμV in dB, as change in percent (Δ%) or as quotient
Multichannel	simultaneous measurement in up to 4 channels; ratio, relative ratio <sup>34)</sup> or difference of results of 2 channels can be displayed (for all functions except Scope)
Display Difference Ratio	in W in dB, as change in percent (Δ%), as quotient or as one of the following matching parameters: SWR, return loss, reflection coefficient
Relative ratio	in dB, as change in percent (Δ%) or as quotient
<b>Display</b>	
Type	LC graphics screen ¼ VGA (320 x 240) pixel, monochrome, transreflective
Backlighting	brightness adjustable
Measurement results	up to 4 results with additional information (Min, Max, Max-Min, frequency) can simultaneously be displayed in separate windows digital, digital and analog
Representation Resolution Digital values	selectable in 4 steps: 0.001 dB/0.01%/4½ digits (W, quotient) 0.01 dB/0.1%/3½ digits (W, quotient) 0.1 dB/1.0%/2½ digits (W, quotient) 1 dB/1.0%/2½ digits (W, quotient) depending on user-definable scale end values
Analog display	
<b>Manual operation</b>	Windows-oriented menus with hot-keys for the most important functions
<b>Remote control</b>	
Systems	IEC 60625.1 (IEEE488.1) and IEC 60625.2 (IEEE488.2)
Command set	SCPI-1999.0
IEC/IEEE bus Interface functions Connector	SH1, AH1, L3, LE3, T5, TE5, SR1, PP1, PP2, RL1, DC1, E2, DT1, C0 24-pin Amphenol (female)
<b>Firmware download</b>	with a Windows-compatible program from the R&S NRP toolkit via the rear-panel USB interface (type B)

Inputs/outputs (rear panel)	
<b>OUT1</b>	
Modes	Analog, Pass/Fail, Off
Analog	recorder output; user-definable linear relation to measurement result (display windows 1 to 4)
Pass/Fail	limit indicator with two user-selectable voltages for identifying the Pass and Fail states in the case of limit monitoring
Off	0 V
Voltage range	0 V to +3.3 V
Setting accuracy	±1% of voltage reading + (0/+8 mV)
Resolution	12 bit (monotone)
Output impedance	1 kΩ
Connector	BNC (female)
<b>IN/OUT 2</b>	
Modes	Analog Out and Trigger In
Analog Out	recorder output; user-definable linear relation to measurement result (display windows 1 to 4)
Electrical characteristics	see OUT1
Trigger In	input for trigger signal to sensors
Maximum voltage	-7 V/+10 V
Logic level	
Low	<0.8 V
High	>2.0 V
Impedance	10 kΩ/100 pF
Connector	BNC (female)
<b>Power supply</b>	
Voltage, frequency	220 V to 240 V, 50 Hz to 60 Hz 100 V to 120 V, 50 Hz to 400 Hz
Tolerance	±10% for voltage and frequency
Apparent power	<80 VA
<b>Dimensions (W x H x D)</b>	274 mm x 112 mm x 267 mm
<b>Weight</b>	<3.0 kg

## Options for R&S NRP

### R&S NRP-B1

Power reference	
Power	1.00 mW
Uncertainty	
20 °C to 25 °C	0.85%
0 °C to 50 °C	1.00%
Frequency	50 MHz
SWR	<1.05 typ.
RF connector	N (female)

### R&S NRP-B2

<b>Second test input (B)</b>	for R&S NRP-Z sensors (available as standard on front panel)
------------------------------	--

### R&S NRP-B5

<b>Third (C) and fourth (D) test inputs</b>	for R&S NRP-Z sensors (only on rear panel)
---	--

### R&S NRP-B6

<b>Rear-panel assembly</b>	for test inputs A and B (only possible if the R&S NRP-B5 option is not installed)
----------------------------	---

## General specifications

<b>Temperature loading<sup>35)</sup></b>	
Operating range and permissible range (in [] if different)	meet IEC 60068
R&S NRP with options	0 °C [-5 °C] to +50 °C
R&S NRP-Z2, -Z11, -Z21	0 °C [-10 °C] to +50 °C [+55 °C]
R&S NRP-Z3	0 °C to +40 °C
Storage range	
R&S NRP with options	-20 °C to +70 °C
R&S NRP-Z2, -Z3, -Z11, -Z21	-40 °C to +70 °C
<b>Climatic resistance</b>	meets IEC 60068
Damp heat	+25 °C/+40 °C cyclic at 95% relative humidity
R&S NRP-Z3, -Z11, -Z21	with restrictions: non-condensing
<b>Mechanical resistance</b>	
Vibration, sinusoidal	meets IEC 60068
	5 Hz to 55 Hz, max. 2 g
	55 Hz to 150 Hz, 0.5 g constant
Vibration, random	meets IEC 60068
	10 Hz to 500 Hz, 1.9 g (rms)
Shock	meets IEC 60068; 40 g shock spectrum
Air pressure	
Operation	795 hPa (2000 m) to 1060 hPa
Transport	566 hPa (4500 m) to 1060 hPa
<b>Electromagnetic compatibility</b>	meets EN 61326, EN 55011
<b>Safety</b>	meets EN 61010-1



- 1)  $\Gamma$  correction activated.
- 2) Referenced to 0 dBm.
- 3) Specifications apply to timeslots with a duration of 12.5% referenced to the signal period (duty cycle 1:8). For other waveforms the following equation applies:  

$$\text{lower measurement limit} = 200 \text{ pW} \times \sqrt{\frac{\text{measurement time/integration time}}{\text{integration time}}}$$
 For measurement time, see specifications. For integration time, see footnote <sup>16)</sup>.  
 4) With a resolution of 256 points.
- 5) Transition regions can be shifted by up to -20 dB if automatic path selection has been chosen.
- 6) The Scope function will be available for the R&S NRP basic unit as of spring 2003.
- 7) Portion of signal that is the subject of measurement (sampling). The factor of 2 is due to the measurement being performed in two equal periods of time (chopper amplifier) separated by 100  $\mu$ s. If averaging is activated, the averaging factor determines the number of measurement windows to be averaged.
- 8) For calculating the pulse power of periodic bursts from an average power measurement.
- 9) To increase measurement speed, the power sensor can be operated in buffered mode. In this mode, measurement results are stored in a buffer of user-definable size and then output as a block of data when the buffer is full. To enhance measurement speed even further, the sensor can be set to record the entire series of measurements when triggered by a single event. In this case the power sensor automatically starts a new measurement as soon as it completes the preceding one.
- 10) This parameter enables power measurements on modulated bursts. The parameter must be longer in duration than modulation-induced power drops within the burst, but at least 10  $\mu$ s shorter than the gap between the end of one burst and the beginning of the next one.
- 11) To exclude unwanted portions at the beginning or end of the measurement window from the measurement result.
- 12) Portion of signal that is the subject of measurement (sampling). Periodic signals are measured in two equal periods of time (chopper amplifier) separated by 100  $\mu$ s. If averaging is activated, the averaging factor determines the number of measurement windows to be averaged.
- 13) To prevent aliasing in the case of signals with discrete modulation frequencies between 100 kHz and 1 MHz.
- 14) Two standard deviations, 10.24 s integration time (see footnote <sup>16)</sup>). Multiplying noise specifications by  $\sqrt{10.24 \text{ s/integration time}}$  yields the noise contribution at other integration times. Smoothing (see under Measurement window) increases noise by 22%.
- 15) Two standard deviations, for power levels greater than 500 nW (-33 dBm) in Continuous Average mode with automatic path selection (User def'd crossover deactivated or set to 0 dB). Within a measurement subrange, relative measurement uncertainty due to noise is inversely proportional to the measured power. The specified values refer to 500 nW (-33 dBm) and the lower limits of paths 2 and 3 at 50  $\mu$ W (-13 dBm) and 5 mW (+7 dBm) respectively.
- 16) Integration time is defined as the total time used for sampling the signal. It can be calculated by multiplying the duration of the measurement window by the averaging factor.
- 17) Expanded uncertainty (k = 2) after zeroing (for 4 s). Zeroing for more than 4 s lowers uncertainty correspondingly (half values for 16 s).
- 18) Within 1 hour after zeroing, permissible temperature change  $\pm 1^\circ\text{C}$ , following 2-hour warm-up of power sensor.
- 19) Magnitude of measurement error with reference to an ideal thermal power sensor that measures the sum power of carrier and harmonics. Specified values apply to automatic path selection (User def'd crossover deactivated or set to 0 dB) and power levels up to +20 dBm. Above +20 dBm, specified values must be multiplied by a factor of 1.25 per 1 dB rise in power level. Within a measurement subrange, errors (uncertainties) are proportional to the measured power in W. The specified values refer to 10  $\mu$ W (-20 dBm) for path 1, 1 mW (0 dBm) for path 2 and 100 mW (20 dBm) for path 3.
- 20) Adhering to specified error limits implies that harmonics above 25 GHz (R&S NRP-Z11) and 56 GHz (R&S NRP-Z21) are at least 20 dB lower than required at other frequencies.
- 21) Measurement error with reference to CW signal of equal power and frequency. Specified values apply to automatic path selection (User def'd crossover deactivated or set to specified value) and power levels up to (+20 dBm + User def'd crossover). Above this level, specified values must be multiplied by a factor of 1.25 per 1 dB rise in power level. In the measurement subranges, the specified values apply to -20 dBm for path 1, 0 dBm for path 2 and +20 dBm for path 3.

- 22) The AUTO mode is not available in conjunction with the R&S NRP basic unit.
- 23) Characteristics like for a conventional power meter. The averaging factor increases continuously as power decreases, but not to the extent that would be necessary to keep the relative noise content at the same level.
- 24) Limits the averaging factor when measuring very low powers or when the noise content is set to a very small value (status information available).
- 25) Reference timeslot and reference point are user-definable.
- 26) Preferably used with determined modulation, when the duration of the measurement window cannot be matched to the modulation period. Compared to a rectangular window, display noise is about 22% higher.
- 27) Valid for Repeat mode, extending from the beginning to the conclusion of all transfers via the USB interface of the power sensor. Measurement times under remote control of the R&S NRP basic unit via IEC/IEEE bus are approximately 2.5 ms longer, extending from the start of the measurement until the measurement result is supplied to the output buffer of the R&S NRP.
- 28) For calculation of measurement time, N must be set to twice the averaging factor if the expression (number of timeslots x nominal width + 100  $\mu$ s + trigger delay) exceeds the trigger period.
- 29) This function can be used to counteract interactions between the signal source and the input of the power sensor (input of a component ahead of the power sensor if s-parameter correction is activated). By using this function, the nominal power of the source into 50  $\Omega$  can be measured (without this correction: power of the incident wave).
- 30) Expanded uncertainty (k = 2) for absolute power measurements on CW signals at calibration levels (-20 dBm for path 1, 0 dBm for paths 2 and 3) and the calibration frequencies (10 MHz, 15 MHz, 20 MHz, 30 MHz, 50 MHz, 100 MHz, from 250 MHz to 8 (18) GHz in increments of 250 MHz). Specifications include zero offset and display noise (up to a 2  $\sigma$  value of 0.004 dB).
- 31) Expanded uncertainty (k = 2) for absolute power measurements on CW signals with automatic path selection. Specifications include display noise with a 2  $\sigma$  value up to 0.01 dB and zero offset for levels from -40 dBm to +23 dBm. Higher display noise and the effect of zero offset at lower levels must be considered separately.  
 Example: Power to be measured is 3.2 nW (-55 dBm) at 1.9 GHz; ambient temperature is 29  $^\circ\text{C}$ ; automatic path selection is set. Typical absolute uncertainty due to zero offset equals 64 pW, corresponding to a relative measurement uncertainty of .

$$10 \times \lg \left( \frac{3.2 \text{ nW} + 64 \text{ pW}}{3.2 \text{ nW}} \right) = 0.086 \text{ dB}$$

Combined with the specified value of 0.081 dB for the uncertainty of absolute power measurements, the total uncertainty is  $\sqrt{0.086^2 + 0.081^2} \text{ dB} = 0.12 \text{ dB}$ . Noise content exceeding 0.01 dB should be considered in the same way.

- 32) Expanded uncertainty (k = 2) for relative power measurements on CW signals with automatic path selection. Specifications include display noise with a 2  $\sigma$  value up to 0.01 dB for both the measurement and the reference level as well as zero offsets for all levels from -40 dBm to +23 dBm. Below -40 dBm, the effect of increased relative zero offset must be taken into account (only for the lower level, if both levels are below -40 dBm). Display noise exceeding 0.01 dB must be considered separately for both the measurement level and the reference level (if applicable). See example in footnote <sup>31)</sup> for calculation of total uncertainty.
- 33) Reading the measurement uncertainty for relative power measurements  
 The example shows a level step of approx. 14 dB (-4 dBm  $\rightarrow$  +10 dBm) at 1.9 GHz and an ambient temperature of 28  $^\circ\text{C}$ .

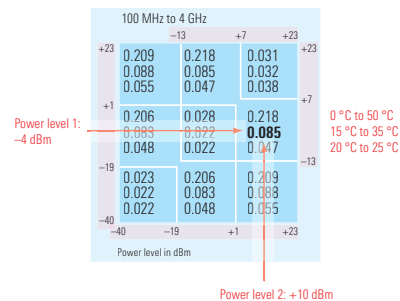

- 34) Quotient of a measured and a stored reference power ratio, e.g. for measuring gain compression of amplifiers.
- 35) The operating temperature range defines the span of ambient temperature in which the instrument complies with specifications. In the permissible temperature range, the instrument is still functioning but adherence to specifications is not warranted.

## Ordering information

Description	Type	Order No.
<b>Basic Unit</b>		
Power Meter	R&S NRP	1143.8500.02
<b>Power Sensors</b>		
200 pW to 200 mW, 10 MHz to 8 GHz	R&S NRP-Z11	1138.3004.02
200 pW to 200 mW, 10 MHz to 18 GHz	R&S NRP-Z21	1137.6000.02
<b>Options</b>		
Sensor Check Source	R&S NRP-B1	1146.9008.02
Second Sensor Input (B)	R&S NRP-B2	1146.8801.02
3rd and 4th Sensor Inputs (C, D) <sup>1)</sup>	R&S NRP-B5	1146.9608.02
Rear-Panel Sensor Inputs A and B <sup>2)</sup>	R&S NRP-B6	1146.9908.02
Battery Supply	R&S NRP-B3	1146.8501.02
<b>Recommended extras</b>		
Sensor Extension Cable to 5 m	R&S NRP-Z2	1146.6750.05
Sensor Extension Cable to 10 m	R&S NRP-Z2	1146.6750.10
USB Adapter (active)	R&S NRP-Z3	1146.7005.02
USB Adapter (passive)	R&S NRP-Z4	1146.8001.02
19" Rack Adapter (R&S NRP + dummy)	R&S ZZA-T26	1109.4387.00
19" Rack Adapter (two R&S NRPs)	R&S ZZA-T27	1109.4393.00

<sup>1)</sup> Option R&S NRP-B2 required.

<sup>2)</sup> Not in conjunction with the R&S NRP-B5.



# ROHDE & SCHWARZ